

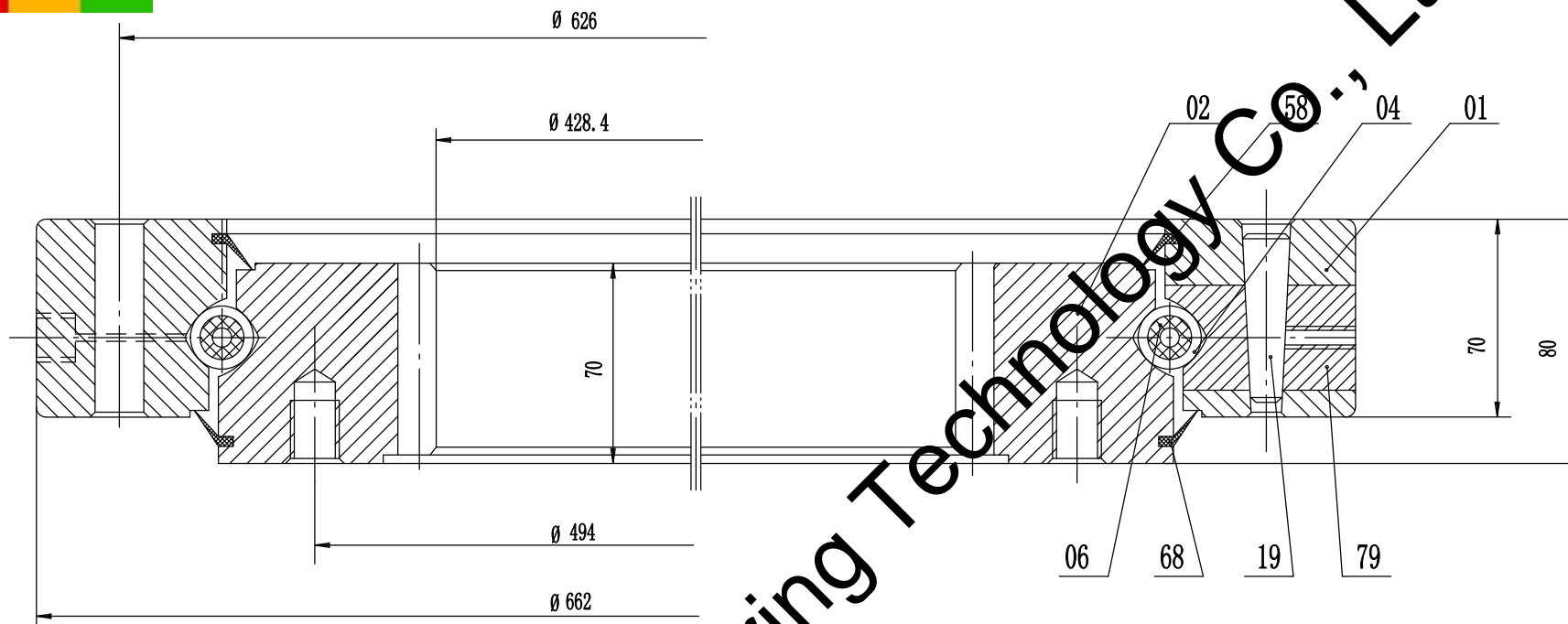

Module	m	6
Number of teeth	z	72
Addendum modification	x	0
Pressure angle	a	20°
Accuracy grade	10-ISO 1328/97	



**Remark:**

1. Luoyang JCB Bearing Technology Co., Ltd is a technical inc, specialize in designing and manufacturing slewing ring bearing, we can design and manufacture all kinds of slewing bearing according to client's requirement.
2. This drawing is reference for user, if you need formal drawing, please contact with us sales@jcb-bearing.com, the official drawing will be submitted after order confirmation.

**Contact information**

Company Address : No.3 Lianmeng road, Luoyang, Henan, China.  
 Postal code : 471003  
 Phone : 86-379-68611675 Fax : 86-379-68611679  
 E-mail: sales@jcb-bearing.com  
 Reserved E-mail: sales@slewing-ring-bearings.com  
 Website: www.jcb-bearing.com  
 www.slewing-ring-bearings.com



Four-point contact ball Slewing Ring Bearing	014. 30. 560	
		Weight(kg)
		94
Luoyang JCB Bearing Technology Co., Ltd		