

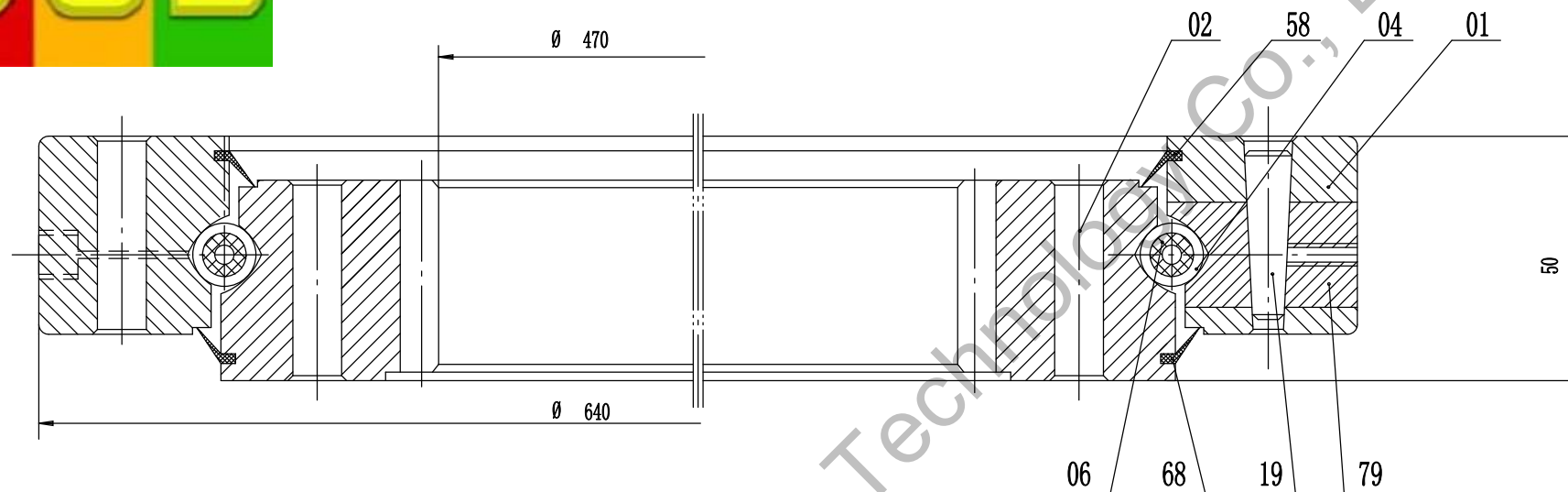

Module	m	5
Number of teeth	Z	96
Addendum modification	x	0
Pressure angle	a	20°
Accuracy grade	10-ISO 1328/97	



Remark:

1. Luoyang JCB Bearing Technology Co., Ltd is a technical Inc, specialize in designing and manufacturing slewing ring bearing, we can design and manufacturer all kinds of slewing bearing according to client's requirement.
2. This drawing is reference for user, if you need formal drawing, please contact wth us sales@jcb-bearing.com, the official drawing will be submitted after order confirmation.

Contact information

Company Address : No.3 Lianmeng road, Luoyang, Henan, China.
 Postal code : 471003
 Phone : 86-379-68611678 Fax : 86-379-68611679
 E-mail: sales@jcb-bearing.com
 Reserved E-mail: sales@slewing-ring-bearings.com
 Website: www.jcb-bearing.com
 www.slewing-ring-bearings.com



Four-point contact ball Slewing Ring Bearing	470DBS114y		
			weight(kg)
			42
	Luoyang JCB Bearing Technology Co., Ltd		